

MMCX
RF CONNECTOR
SURFACE MOUNT

Hexawave
SPDT SWITCH
HWS466

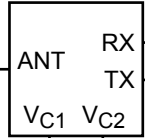

Murata
2.3GHz TO 2.4GHz
SAWBPF
SAFEA2G34FB0F00

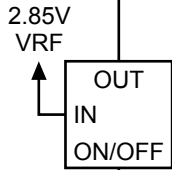
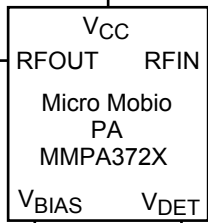

2.85V (VRF)
2.85V (VSYNTH)

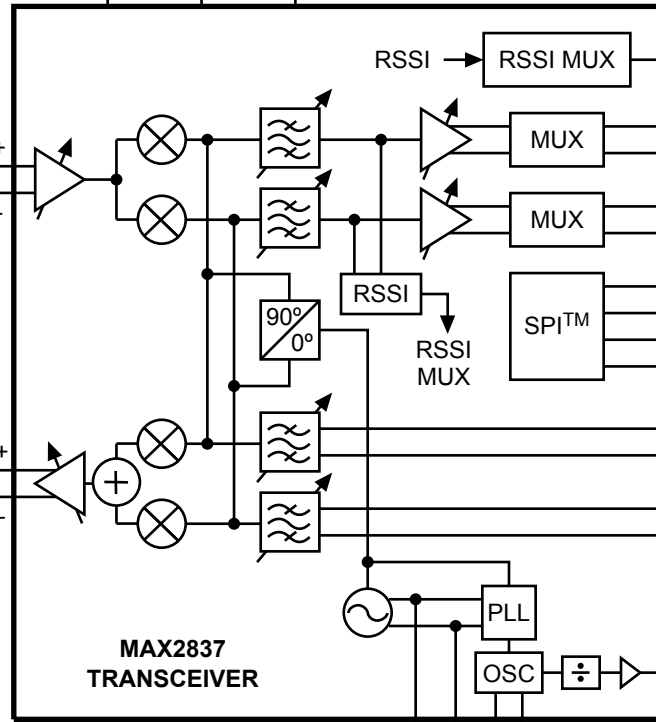

KSS VC-TCXO 214C6
VCTCXO (40MHz)

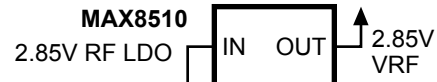
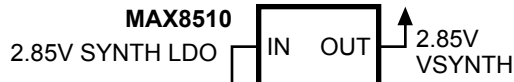
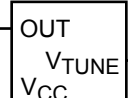

- R1_B1-R1_B7 #45, 47, 49, 51, 53, 55, 57
- R1_RSSI #79
- R1_RXHP #41
- R1_RXBBI+ #11
- R1_RXBBI- #9
- R1_RXBBQ+ #5
- R1_RXBBQ- #3
- SCLK #27
- DIN #31
- DOOUT #33
- R1_CS/ #29
- R1_TXBBI+ #17
- R1_TXBBI- #15
- R1_TXBBQ+ #21
- R1_TXBBQ- #23
- R1_ENABLE #35
- R1_RXENABLE #37
- R1_TXENABLE #39
- R1_REFCLKOUT #63
- R1_REFCLKIN #61
- FREQ_STEER #67
- R1_PWRDET #69
- R1_PAENABLE #71
- R1_TRSW2 #77
- R1_TRSW1 #75
- +3.3V (VBATT) #113-118

124-PIN BOARD EDGE CONNECTOR FOR WIBro AND WIMAX INTERFACE BOARD